

# Transient Voltage Suppressors Array for ESD Protection

## SE08T2V02GC

### Features

- ◆ Working voltage : 8V
- ◆ Low leakage current: 1.0 $\mu$ A @  $V_{RWM}$
- ◆ Low clamping voltage
- ◆ Response Time is < 1 ns

### SOT23-3L

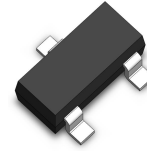

### Applications

- ◆ RS-232, RS-422 & RS-423 Data Lines
- ◆ Audio/Video Inputs
- ◆ Wireless Network Systems
- ◆ Digit Video Interface (DVI)

### Pin Configuration

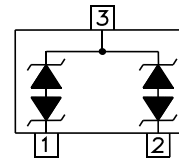

### Mechanical Characteristics

- ◆ SOT23-3L Package
- ◆ Molding Compound Flammability Rating : UL 94V-0
- ◆ Quantity Per Reel : 3,000pcs
- ◆ Reel Size : 7 inch
- ◆ Marking Code: C08

### Absolute Maximum Rating

Symbol	Parameter	Value	Units
$T_{LST}$	Lead Soldering Temperature	260 (10sec)	$^{\circ}$ C
$T_{STG}$	Storage Temperature Range	-55 to +150	$^{\circ}$ C
$T_{OPT}$	Operating Temperature Range	-55 to +150	$^{\circ}$ C
$V_{ESD}$	ESD per IEC 61000-4-2(Air)	$\pm$ 30	KV
	ESD per IEC 61000-4-2 (Contact)	$\pm$ 30	

# Transient Voltage Suppressors Array for ESD Protection

## SE08T2V02GC

### I-V Curve Characteristics

Symbol	Parameter
$I_{PP}$	Maximum Reverse Peak Pulse Current
$V_C$	Clamping Voltage @ $I_{PP}$
$V_{RWM}$	Working Peak Reverse Voltage
$I_R$	Maximum Reverse Leakage Current @ $V_{RWM}$
$V_{BR}$	Breakdown Voltage @ $I_T$
$I_T$	Test Current

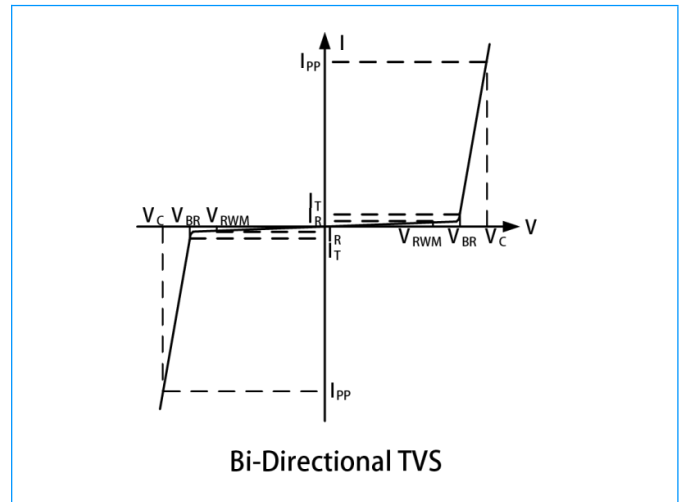

### Electrical Characteristics (@ $T_A=25^\circ\text{C}$ Unless Otherwise Specified )

Symbol	Test Condition	Minimum	Typical	Maximum	Units
$V_{RWM}$	--	--	--	8	V
$I_R$	$V_{RWM}=8\text{V}, T=25^\circ\text{C}$	--	--	1	$\mu\text{A}$
$V_{BR}$	$I_T = 1\text{mA}$	9	--	--	V
$V_C$	$I_{PP}=1\text{A}, t_p=8/20\mu\text{s}$	--	--	15	V
$V_C$	$I_{PP}=15\text{A}, t_p=8/20\mu\text{s}$	--	--	25	V
$C_J$	$V_R=0\text{V}, f=1\text{MHz}$	--	75	--	pF

### Characteristic Curves

**Fig1. 8/20 $\mu\text{s}$  Pulse Waveform**

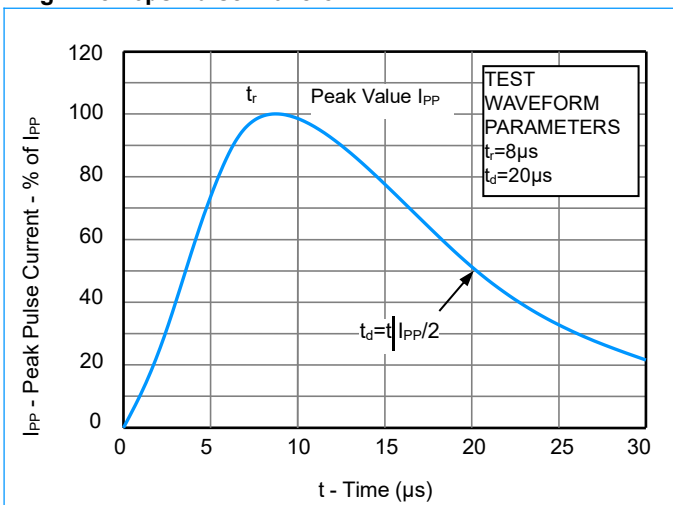

**Fig2. ESD Pulse Waveform (according to IEC 61000-4-2)**

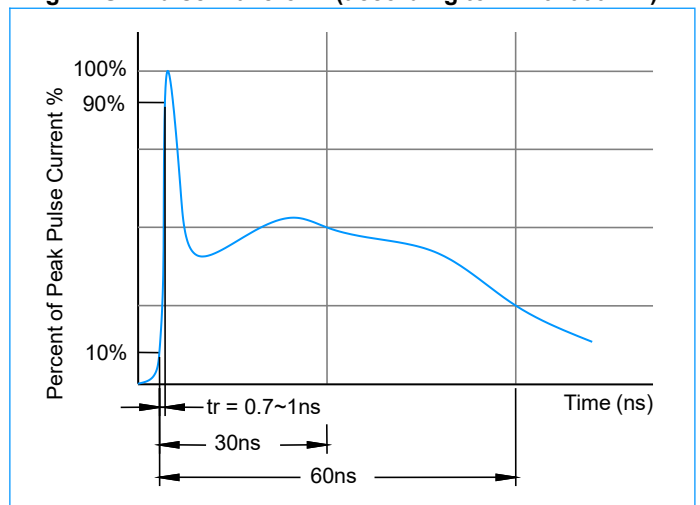

# Transient Voltage Suppressors Array for ESD Protection

## SE08T2V02GC

### Characteristic Curves (Continue)

Fig3. ESD Clamping (+8KV Contac per IEC61000-4-2)

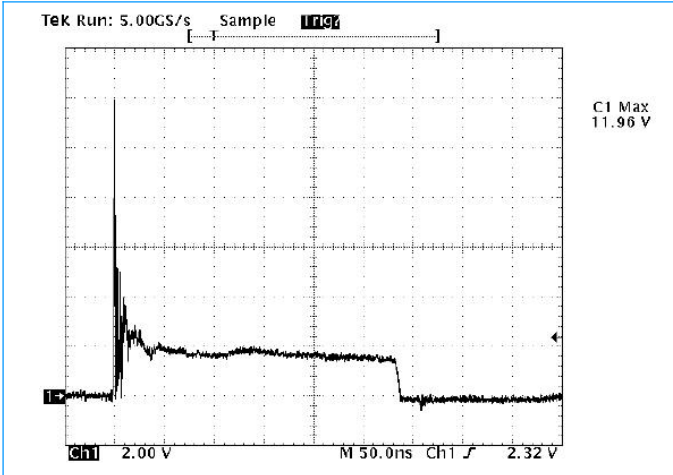
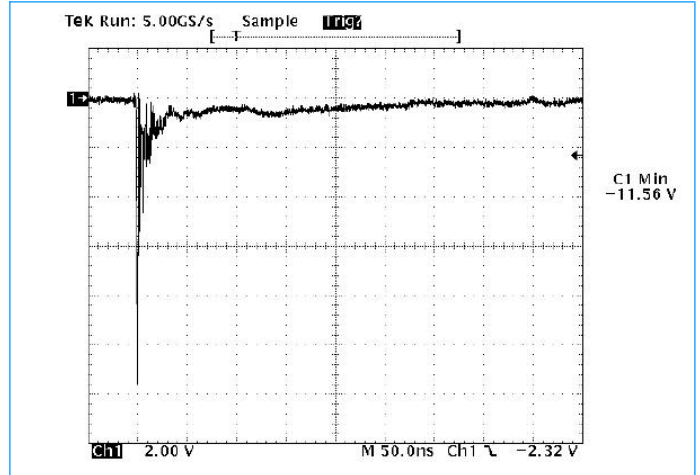
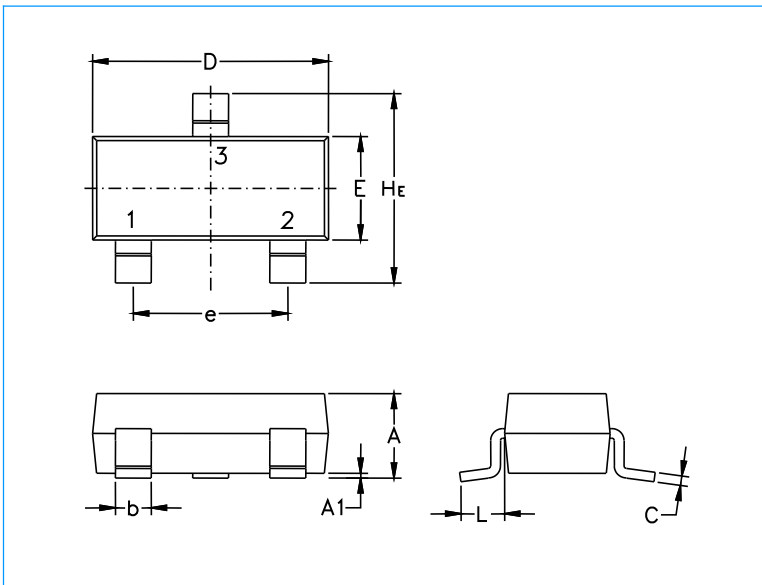

Fig4. ESD Clamping (-8KV Contac per IEC61000-4-2)



### SOT23-3L Package Outline & Dimensions



Symbol	Millimeters			Inches		
	Min.	Nom.	Max.	Min.	Nom.	Max.
A	0.89	1.00	1.11	0.035	0.040	0.044
A1	0.01	0.06	0.10	0.001	0.002	0.004
b	0.37	0.44	0.50	0.15	0.18	0.020
c	0.09	0.13	0.18	0.003	0.005	0.007
D	2.80	2.90	3.04	0.110	0.114	0.120
E	1.20	1.30	1.40	0.047	0.051	0.055
e	1.78	1.90	2.04	0.070	0.075	0.081
L	0.35	0.54	0.69	0.014	0.021	0.029
He	2.10	2.40	2.64	0.083	0.094	0.104

### Soldering Footprint

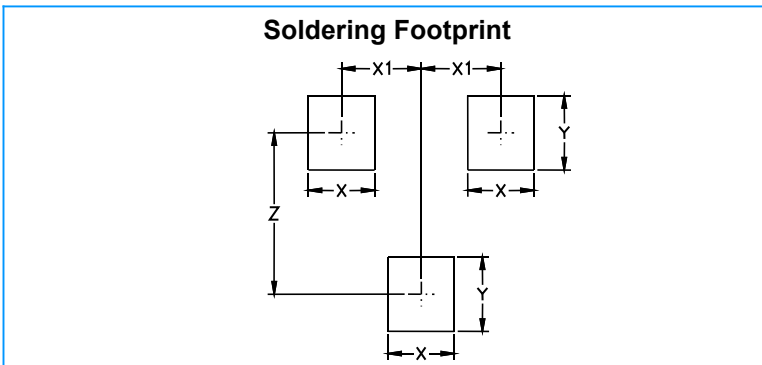

Symbol	Millimeters	Inches
X	0.80	0.031
X1	0.95	0.037
Y	0.90	0.035
Z	2.00	0.079