

Transient Voltage Suppressors for ESD Protection

SE12D3V01GZ

Features

- ⌌ Working voltage : 12V
- ⌌ Low leakage current: 0.01 μ A @ V_{RWM} (Typical)
- ⌌ Low clamping voltage
- ⌌ Response Time is < 1 ns

SOD-323

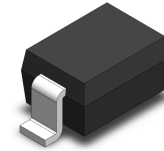

Applications

- ⌌ Cellular Handsets and Accessories
- ⌌ High Speed I/O Lines
- ⌌ Notebooks & Handhelds
- ⌌ Peripherals

Pin Configuration



Mechanical Characteristics

- ⌌ SOD-323 Package
- ⌌ Molding Compound Flammability Rating : UL 94V-0
- ⌌ Quantity Per Reel : 3,000pcs
- ⌌ Reel Size : 7 inch

Absolute Maximum Ratings ($T_A=25^{\circ}\text{C}$, RH=45%-75%, unless otherwise noted)

Symbol	Parameter	Value	Units
T_J	Operating Junction Temperature	125	$^{\circ}\text{C}$
T_{STG}	Storage Temperature Range	-55 to +150	$^{\circ}\text{C}$
I_{PP}	Peak Pulse Current ($t_P = 8/20\mu\text{s}$)	15	A
V_{ESD}	ESD per IEC 61000-4-2 (Air)	± 30	KV
	ESD per IEC 61000-4-2 (Contact)	± 30	

Transient Voltage Suppressors for ESD Protection

SE12D3V01GZ

I-V Curve Characteristics

Symbol	Parameter
I_{PP}	Maximum Peak Pulse Current
V_C	Clamping Voltage @ I_{PP}
V_{RWM}	Working Peak Reverse Voltage
I_R	Maximum Reverse Leakage Current @ V_{RWM}
V_{BR}	Breakdown Voltage @ I_T
I_T	Test Current

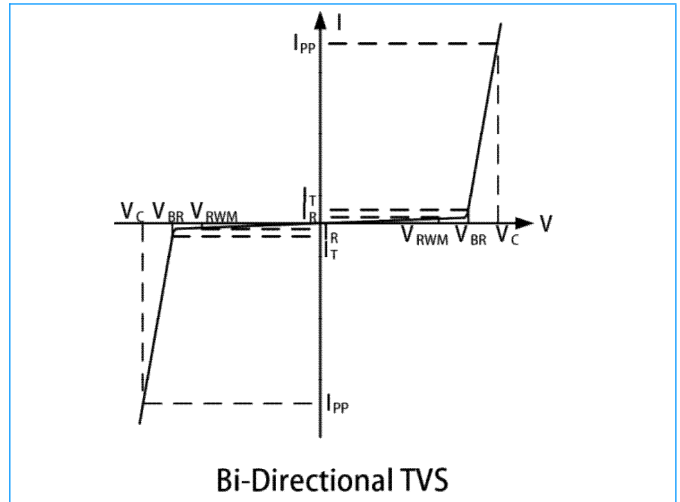

Electrical Characteristics (@ $T_A=25^{\circ}C$ Unless Otherwise Specified)

Parameter	Symbol	Test Condition	Min.	Typ.	Max.	Unit
Reverse Working Voltage	V_{RWM}	--	--	--	12.0	V
Reverse Breakdown Voltage	V_{BR}	$I_T = 1mA$	13.3	14.4	16.0	V
Reverse Leakage Current	I_R	$V_{RWM} = 12V$	--	0.01	1.0	μA
Clamping Voltage	V_C	$I_{PP} = 15A, t_P = 8/20\mu s$	--	22.0	30.0	V
Junction Capacitance	C_J	$V_{RWM} = 0V, f = 1MHz$	--	70.0	--	pF

Characteristic Curves

Fig1. 8/20 μs Pulse Waveform

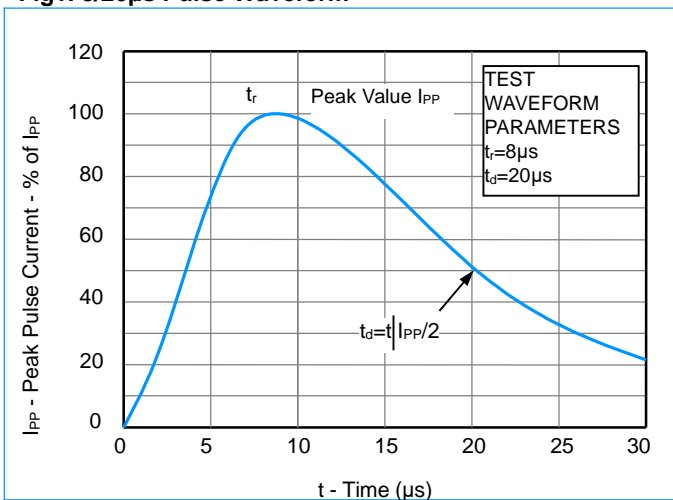
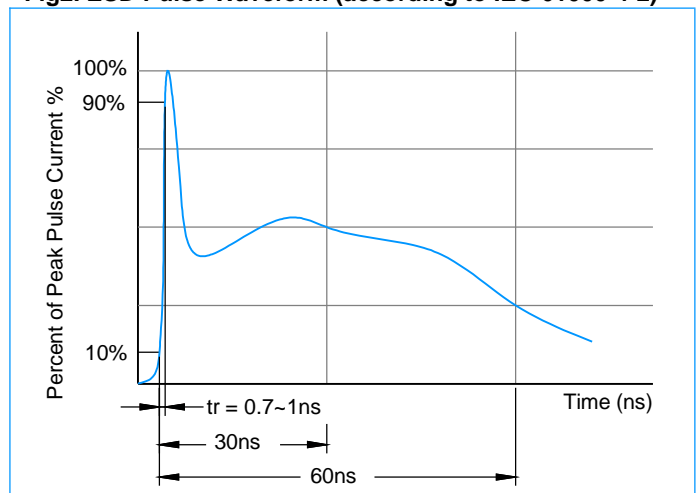

Fig2. ESD Pulse Waveform (according to IEC 61000-4-2)



Transient Voltage Suppressors for ESD Protection

SE12D3V01GZ

Characteristic Curves (Continue)

Fig3. ESD Clamping (+8KV Contac per IEC61000-4-2)

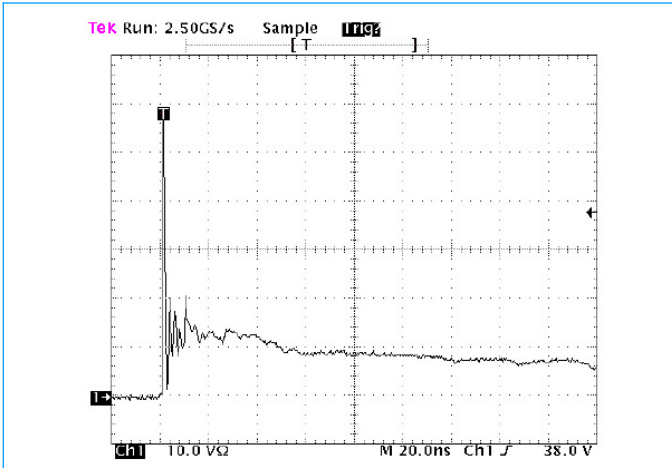
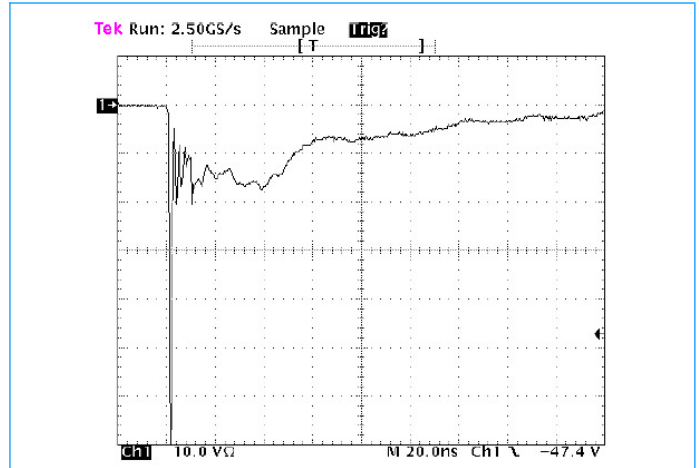
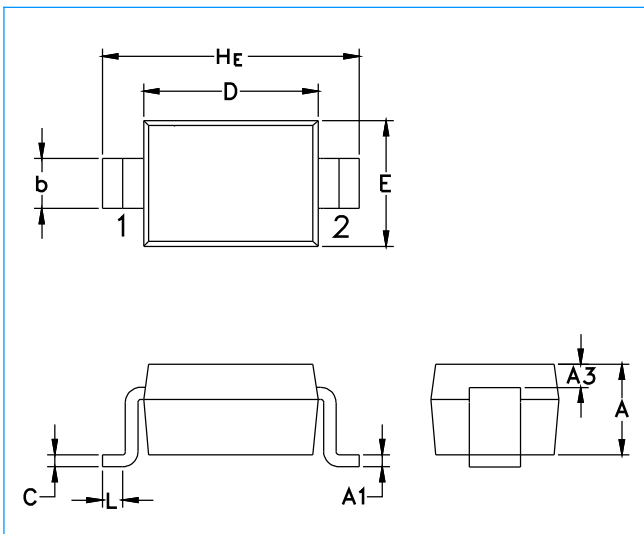

Fig4. ESD Clamping (-8KV Contac per IEC61000-4-2)



SOD-323 Package Outline & Dimensions



Symbol	Millimeters			Inches		
	Min.	Nom.	Max.	Min.	Nom.	Max.
A	0.80	0.90	1.00	0.031	0.035	0.040
A1	0.00	0.05	0.10	0.000	0.002	0.004
A3	0.15 REF			0.006 REF		
b	0.25	0.32	0.40	0.010	0.012	0.016
C	0.089	0.12	0.177	0.003	0.005	0.007
D	1.60	1.70	1.80	0.062	0.066	0.070
E	1.15	1.25	1.35	0.045	0.049	0.053
L	0.08			0.003		
HE	2.30	2.50	2.70	0.090	0.098	0.105

Soldering Footprint

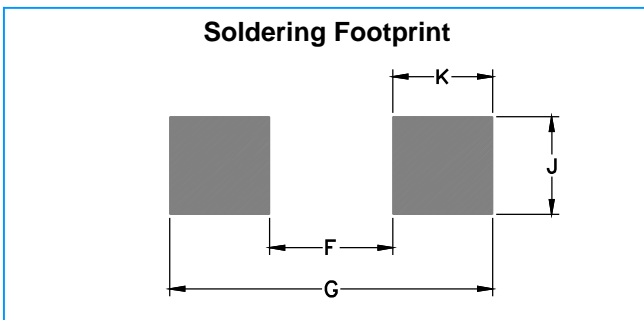

Symbol	Millimeters	Inches
F	1.60	0.063
G	2.85	0.112
J	0.83	0.033
K	0.63	0.025