

Transient Voltage Suppressors for ESD Protection

SE4V5700D-32

Features

- ◆ Protects one I/O line (bidirectional)
- ◆ Low clamping voltage
- ◆ Working voltages: 4.5V
- ◆ Low leakage current
- ◆ IEC61000-4-2 (ESD) ±15kV (air), ±8kV (contact)

SOD-323

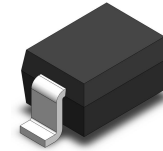

Applications

- ◆ Cell Phone Handsets and Accessories
- ◆ Microprocessor based equipment
- ◆ Personal Digital Assistants (PDA's)
- ◆ Notebooks, Desktops, and Servers
- ◆ Portable Instrumentation
- ◆ Peripherals
- ◆ USB Interface

Functional Diagram

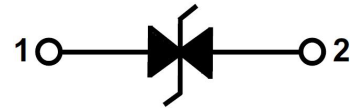

Mechanical Characteristics

- ◆ JEDEC SOD-323 Package
- ◆ Molding Compound Flammability Rating : UL 94V-0
- ◆ Weight 5.0 Milligrams (Approximate)
- ◆ Quantity Per Reel : 3,000pcs
- ◆ Reel Size : 7 inch
- ◆ Lead Finish : Lead Free

Marking Code

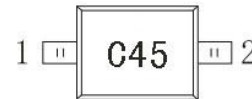

Mechanical Characteristics

Symbol	Parameter	Value	Units
I _{PP}	Peak Pulse Current (tp=8/20μs waveform)	140	A
T _L	Lead Soldering Temperature	260 (10 sec)	°C
T _J	Operating Junction Temperature Range	-55 to +125	°C
T _{STG}	Storage Temperature Range	-55 to +150	°C
T _{OP}	Operating Temperature Range	-55 to +150	°C

Transient Voltage Suppressors for ESD Protection

SE4V5700D-32

I-V Curve Characteristics

Symbol	Parameter
I_{PP}	Maximum Reverse Peak Pulse Current
V_C	Clamping Voltage @ I_{PP}
V_{RWM}	Working Peak Reverse Voltage
I_R	Maximum Reverse leakage Current @ V_{RWM}
I_T	Test Current
V_B	Breakdown Voltage @ I_T

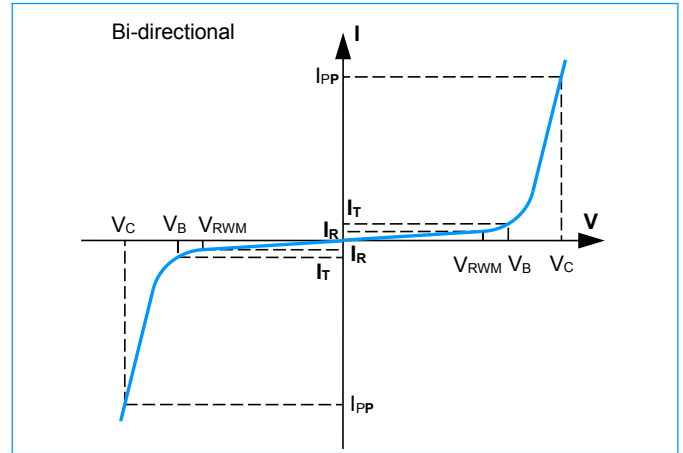

Electrical Characteristics ($T_A = 25^\circ C$)

Parameter	Symbol	Conditions	Min.	Typ.	Max.	Units
Reverse Stand-off Voltage	V_{RWM}	--	--	--	4.5V	V
Reverse Breakdown Voltage	V_{BR}	$I_t = 1mA$	4.7	5	--	V
Reverse Leakage Current	I_R	$V_{RWM} = +/-4.5V$	--	--	100	nA
Junction Capacitance ⁽¹⁾	C_J	$V_R = 0V, f = 1MHz$	--	70	--	pF
Clamping Voltage ⁽¹⁾	V_C	TLP=16A or ESD=8KV	--	7	--	V
Clamping Voltage ⁽¹⁾	V_C	$I_{PP} = 1A, t_P = 8/20\mu s$	--	6	--	V
		$I_{PP} = 140A, t_P = 8/20\mu s$	--	13	--	V

Note: (1) Guaranteed by design.

Characteristic Curves

Fig1. 8/20 μs Pulse Waveform

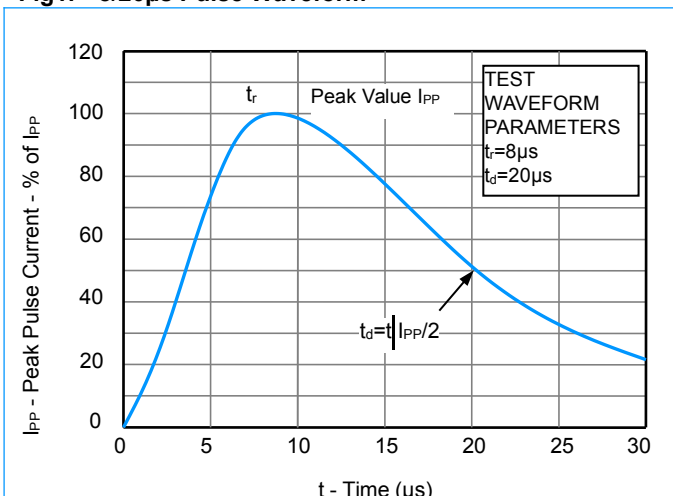
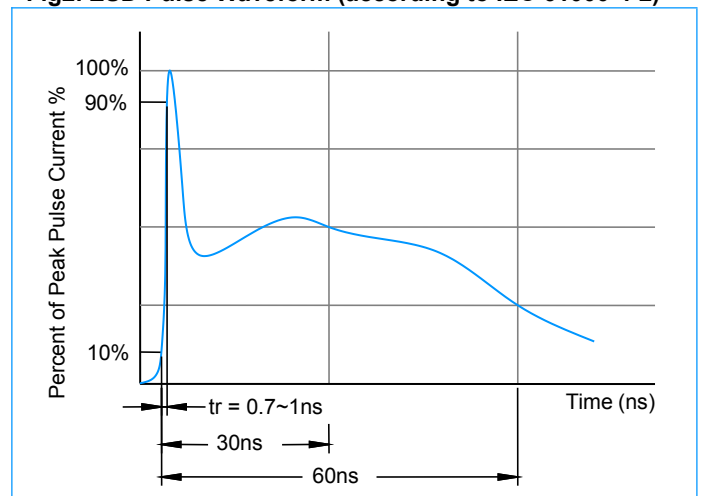

Fig2. ESD Pulse Waveform (according to IEC 61000-4-2)



Transient Voltage Suppressors for ESD Protection

SE4V5700D-32

Characteristic Curves (Continue)

Fig3. ESD Clamping (+8KV Contac per IEC61000-4-2)

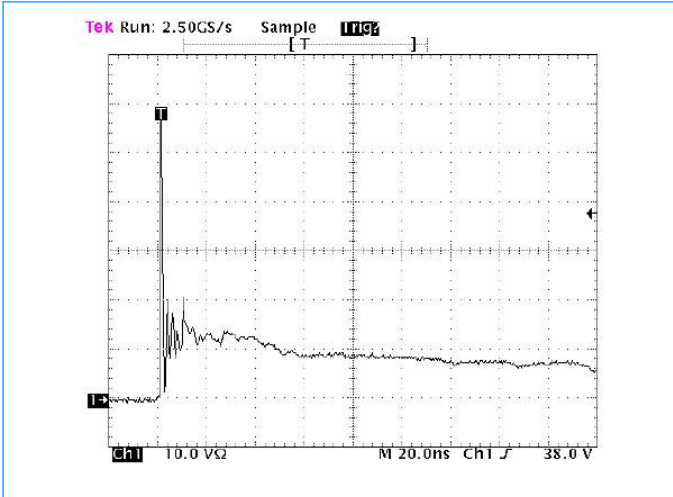
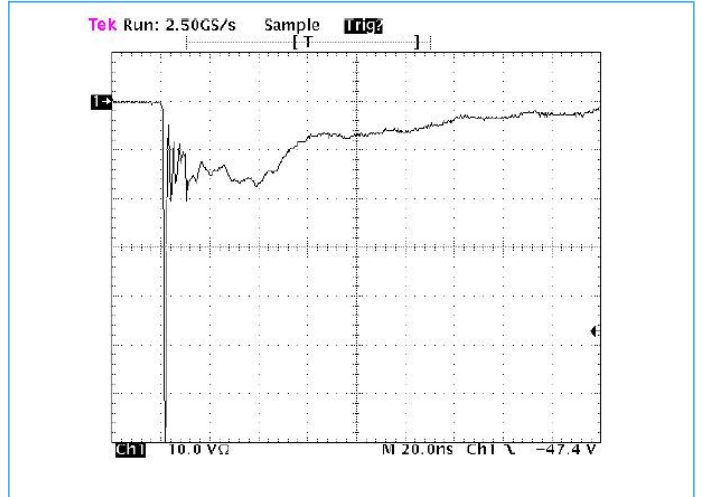
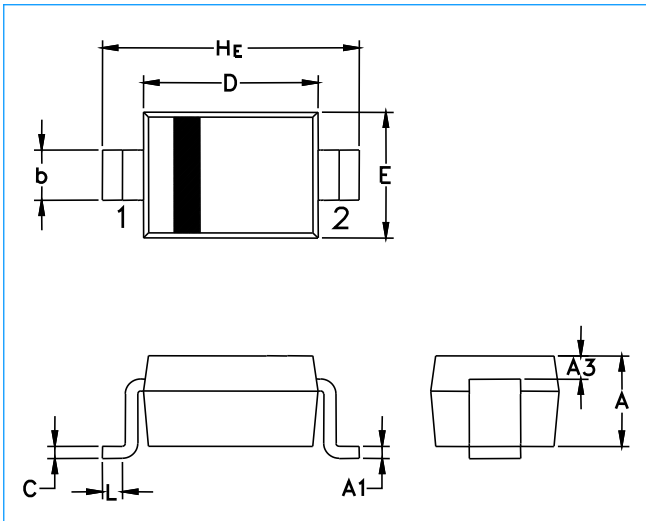

Fig4. ESD Clamping (-8KV Contac per IEC61000-4-2)



SOD-323 Package Outline & Dimensions



Symbol	Millimeters			Inches		
	Min.	Nom.	Max.	Min.	Nom.	Max.
A	0.80	0.90	1.00	0.031	0.035	0.040
A1	0.00	0.05	0.10	0.000	0.002	0.004
A3	0.15 REF			0.006 REF		
b	0.25	0.32	0.40	0.010	0.012	0.016
C	0.089	0.12	0.177	0.003	0.005	0.007
D	1.60	1.70	1.80	0.062	0.066	0.070
E	1.15	1.25	1.35	0.045	0.049	0.053
L	0.08	--	--	0.003	--	--
H _E	2.30	2.50	2.70	0.090	0.098	0.105

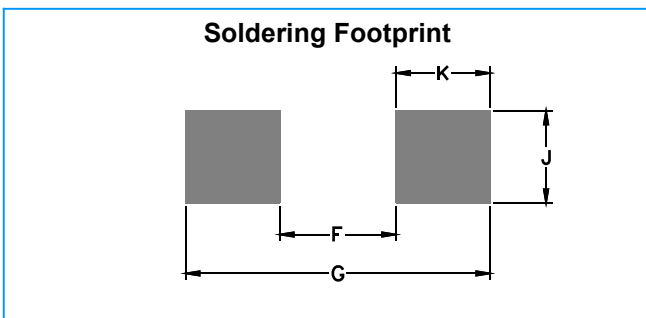

Symbol	Millimeters	Inches
F	1.60	0.063
G	2.85	0.112
J	0.83	0.033
K	0.63	0.025