

Transient Voltage Suppressors for ESD Protection

ESDXXV32D-A Series

Description

The ESDXXV32D-A is designed to protect voltage sensitive components from ESD and transient voltage events. Excellent clamping capability, low leakage, and fast response time, make these parts ideal for ESD protection on designs where board space is at a premium. Because of its small size, it is suited for use in cellular phones, MP3 players, digital cameras and many other portable applications where board space is at a premium.

Feature

- u 225~408 Watts Peak Pulse Power per Line (tp=8/20μs)
- u Protects one I/O line or power line
- u Low clamping voltage
- u Working voltages : 3V, 5V, 8V, 12V, 15V,24V and 36V
- u Low leakage current
- u IEC61000-4-2 (ESD) ±15kV (air), ±8kV (contact)
- u IEC61000-4-4 (EFT) 40A (5/50ns)
- u IEC61000-4-5 (Lightning) 24A (8/20μs)

Applications

- u Cell Phone Handsets and Accessories
- u Microprocessor based equipment
- u Personal Digital Assistants (PDA's)
- u Notebooks, Desktops, and Servers
- u Portable Instrumentation
- u Peripherals
- u Pagers

SOD-323

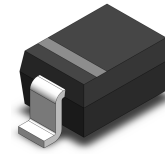

Functional Diagram

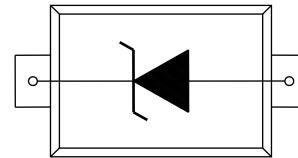

Mechanical Characteristics

- u JEDEC SOD-323 Package
- u Molding Compound Flammability Rating : UL 94V-0
- u Weight 5 Milligrams (Approximate)
- u Quantity Per Reel : 3,000pcs
- u Reel Size : 7 inch
- u Lead Finish : Lead Free

Mechanical Characteristics

Symbol	Parameter	Value	Units	
T _L	Lead Soldering Temperature	260 (10sec)	°C	
T _{STG}	Storage Temperature Range	-55 to +150	°C	
T _{OP}	Operating Temperature Range	-55 to +150	°C	
	IEC61000-4-2 (ESD)	Air Discharge Contact Discharge	±15 ±8	KV
	IEC61000-4-4 (EFT)	40	A	
	IEC61000-4-5 (Lightning)	24	A	

Transient Voltage Suppressors for ESD Protection

ESDXXV32D-A Series

I-V Curve Characteristics

Symbol	Parameter
I_{PP}	Maximum Reverse Peak Pulse Current
V_C	Clamping Voltage @ I_{PP}
V_{RWM}	Working Peak Reverse Voltage
I_R	Maximum Reverse leakage Current @ V_{RWM}
I_T	Test Current
V_B	Breakdown Voltage @ I_T
I_F	Forward Current
V_F	Forward Voltage @ I_F
P_{PK}	Peak Power Dissipation
C	Max Capacitance @ $V_R=0V$ & $f=1MHz$

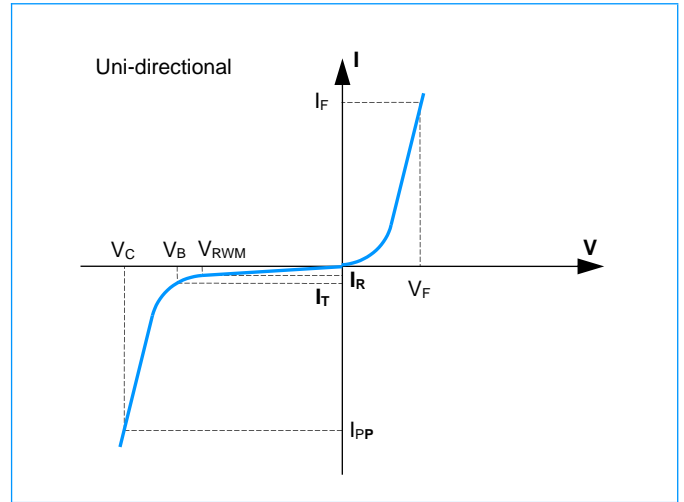

Electrical Characteristics (@ 25°C Unless Otherwise Specified)

Part Number	Device Marking	V_{RWM} (V) (Max.)	V_B (V) (Min.)	I_T (mA)	V_C @1A (Max.)	V_C		I_R (μA) (Max.)	C (pF) (Typ.)	P_{PP} (W) ($t_p=8/20\mu s$ wave form)
						(Max.)	(@A)			
ESD03V32D-A	03W	3	3.8	1	7.5	16	25	40	350	400
ESD05V32D-A	05W	5	6.0	1	9.8	17	24	5	300	408
ESD08V32D-A	08W	8	7.8	1	13.4	20	18	3	200	360
ESD12V32D-A	12W	12	13.3	1	20	30	11	1	100	330
ESD15V32D-A	15W	15	16.7	1	25	36	9	1	90	324
ESD24V32D-A	24W	24	26.7	1	45	50	5	1	80	250
ESD36V32D-A	36W	36	40.0	1	65	75	3	1	48	225

Characteristic Curves

Fig1. 8/20 μs Pulse Waveform

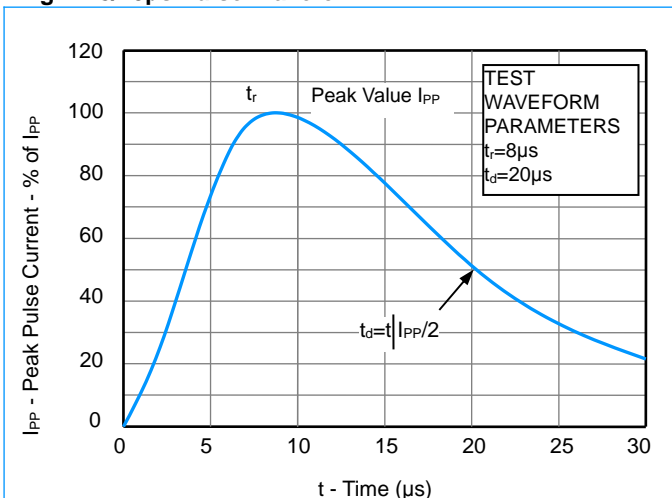
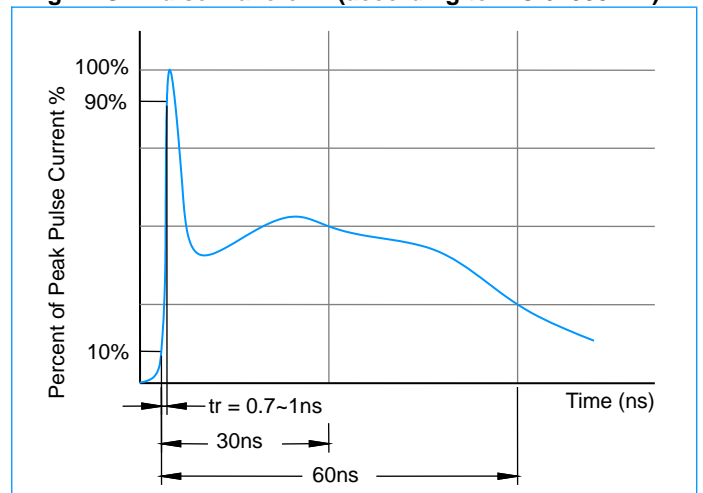

Fig2. ESD Pulse Waveform (according to IEC 61000-4-2)



Transient Voltage Suppressors for ESD Protection

ESDXXV32D-A Series

Characteristic Curves

Fig3. ESD Clamping (+8KV Contac per IEC61000-4-2)

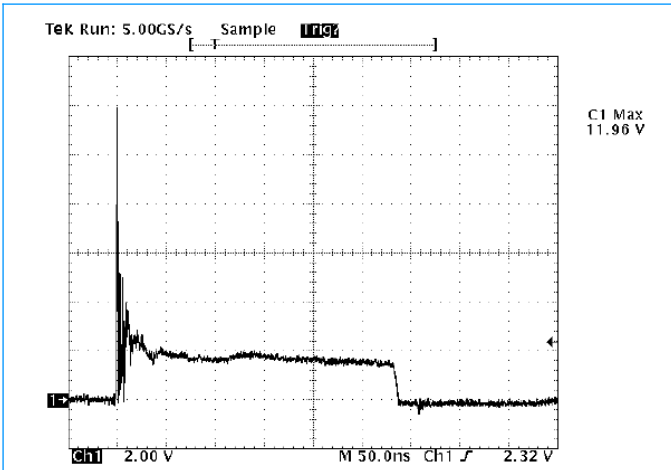
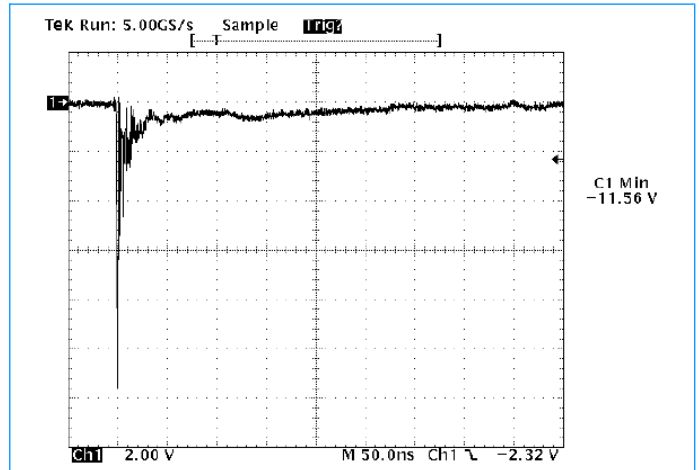
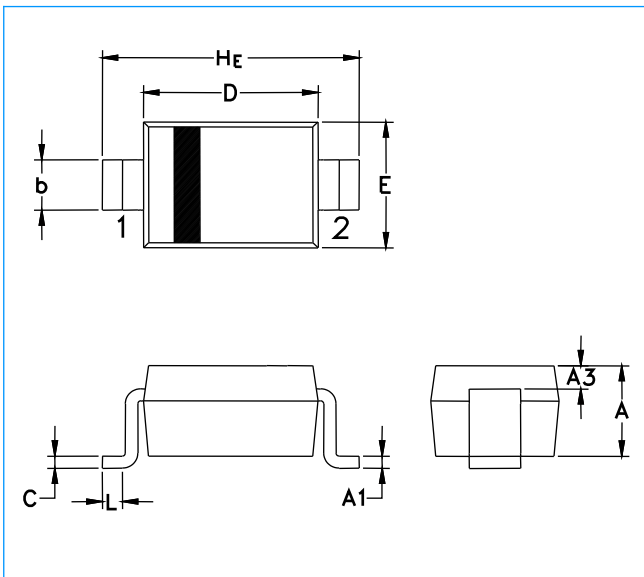

Fig4. ESD Clamping (-8KV Contac per IEC61000-4-2)



SOD-323 Package Outline & Dimensions



Symbol	Millimeters			Inches		
	Min.	Nom.	Max.	Min.	Nom.	Max.
A	0.80	0.90	1.00	0.031	0.035	0.040
A1	0.00	0.05	0.10	0.000	0.002	0.004
A3	0.15 REF			0.006 REF		
b	0.25	0.32	0.40	0.010	0.012	0.016
C	0.089	0.12	0.177	0.003	0.005	0.007
D	1.60	1.70	1.80	0.062	0.066	0.070
E	1.15	1.25	1.35	0.045	0.049	0.053
L	0.08	—	—	0.003	—	—
HE	2.30	2.50	2.70	0.090	0.098	0.105

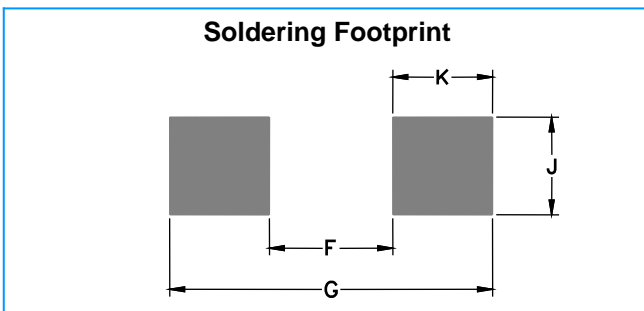

Symbol	Millimeters	Inches
F	1.60	0.063
G	2.85	0.112
J	0.83	0.033
K	0.63	0.025